

NACHT BORD.

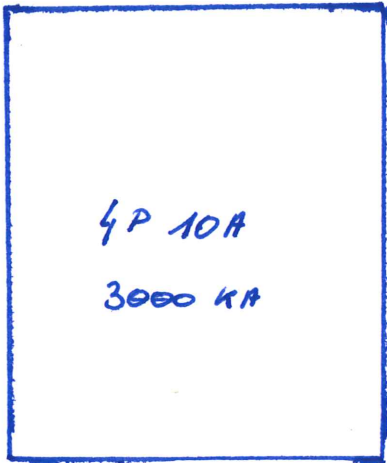

ACC U 1



ACC U 2

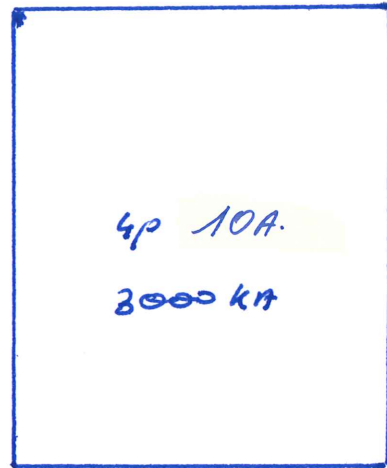

ACC U 3

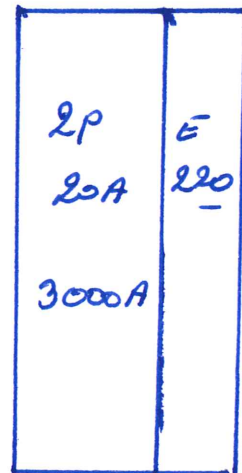
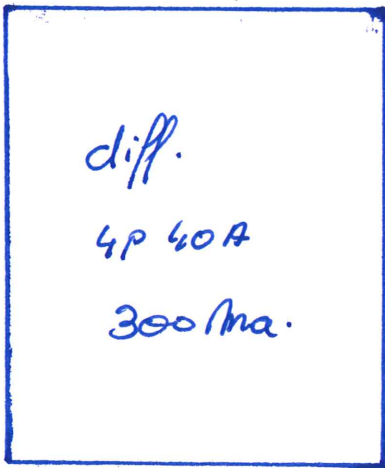

DAGBORD

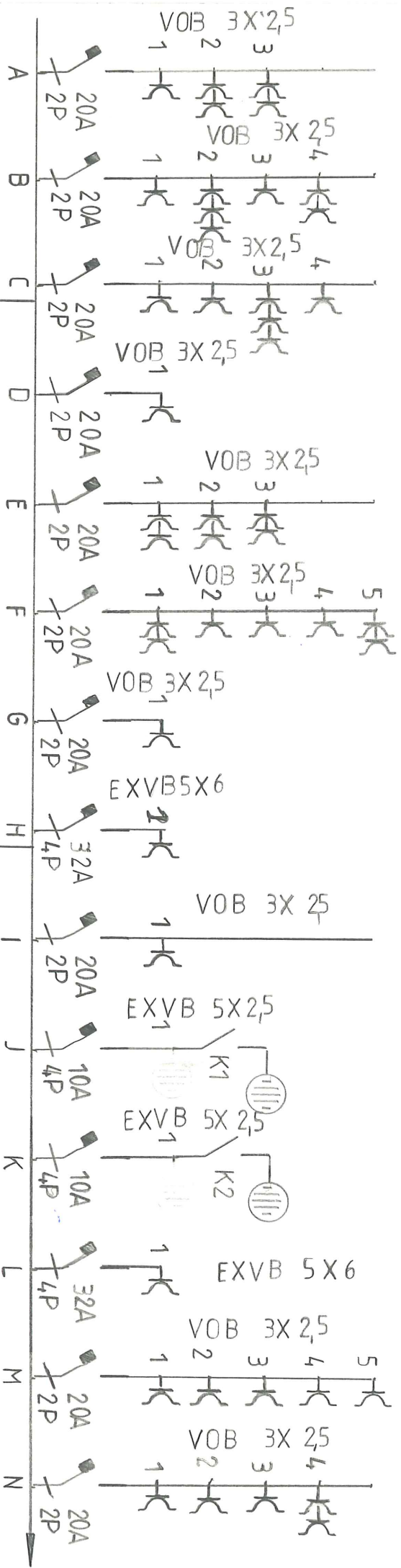

VOB 16
LUS 35A

4X16

kWh

4P4,0A
Δ300

Voor A. J. B. VINCOTTE
GERIJS
0214

DE AFGEVAARDE

VAN EEN ERKENNEND ORGANISME

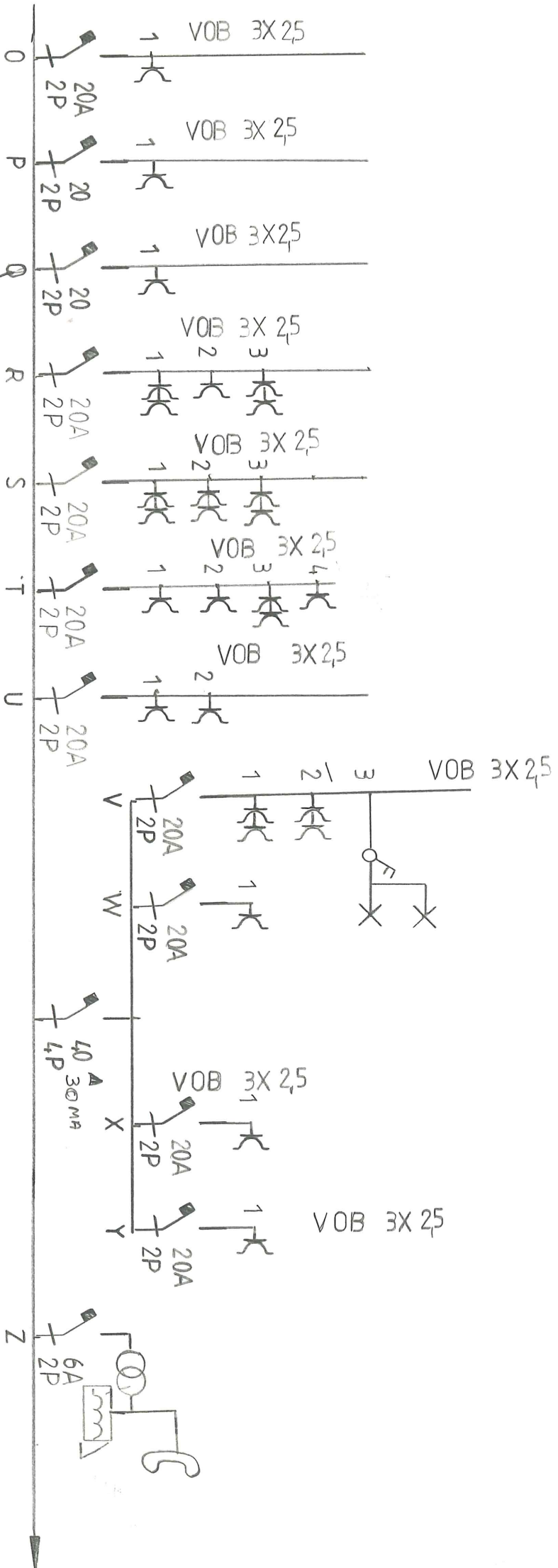

DE AFGEV. V/H
ERKENN. ORGANISME

DE VERANTWOORDELIJKE
V/D UITVOERING V/H WERK

DE EIGENNAAR

Voor A. B. J. M. M. G. G. H. E.
G. E. R. I. J. S. A.
0214

1^o Verloop.

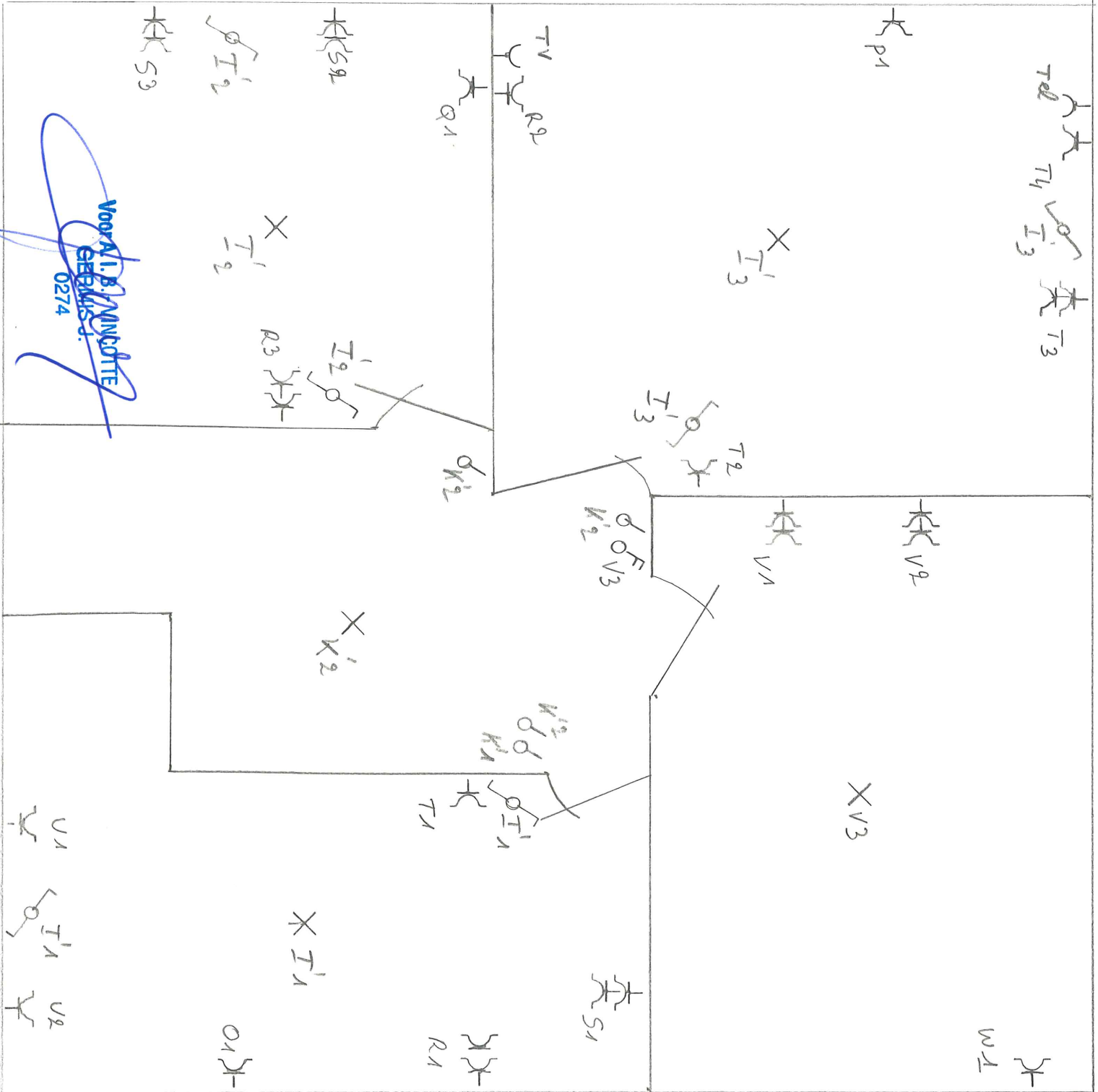

Voorz. I. B. MINSCHTE
GERBINSJ.
0274

helden

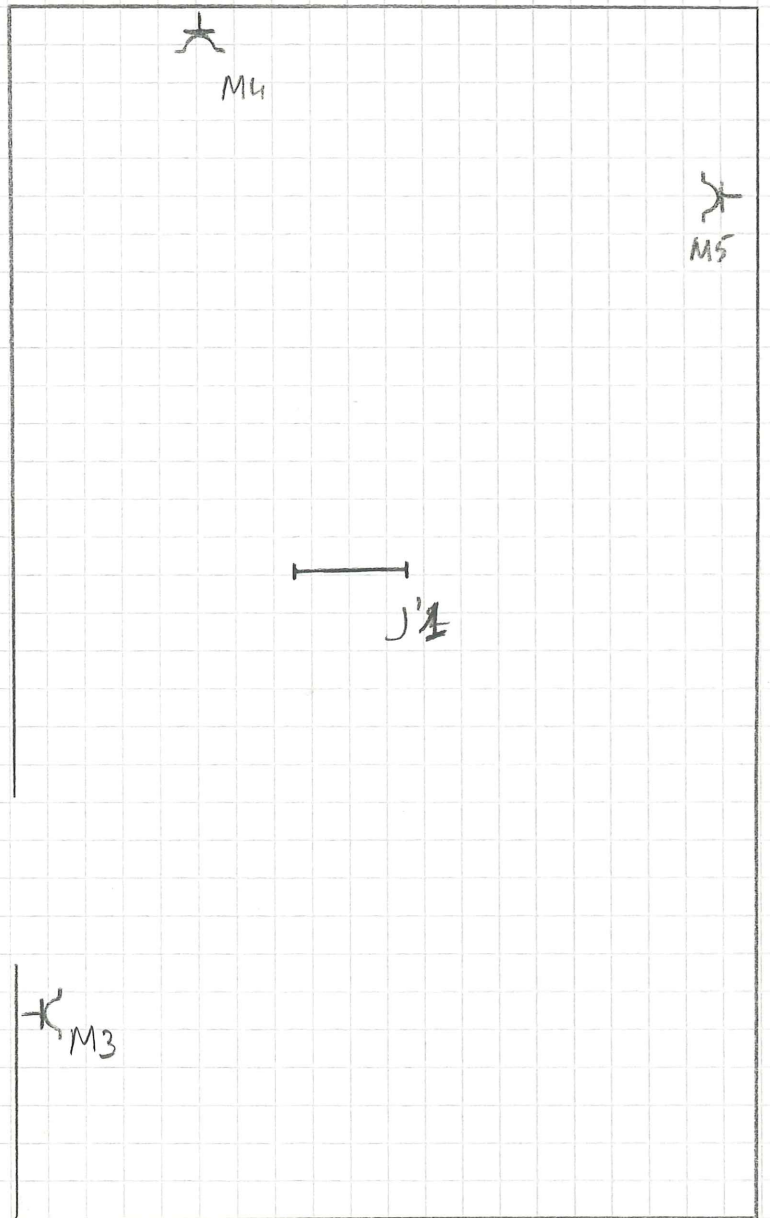

Voor A.T.B. J. M. MOORE
GERINSL.

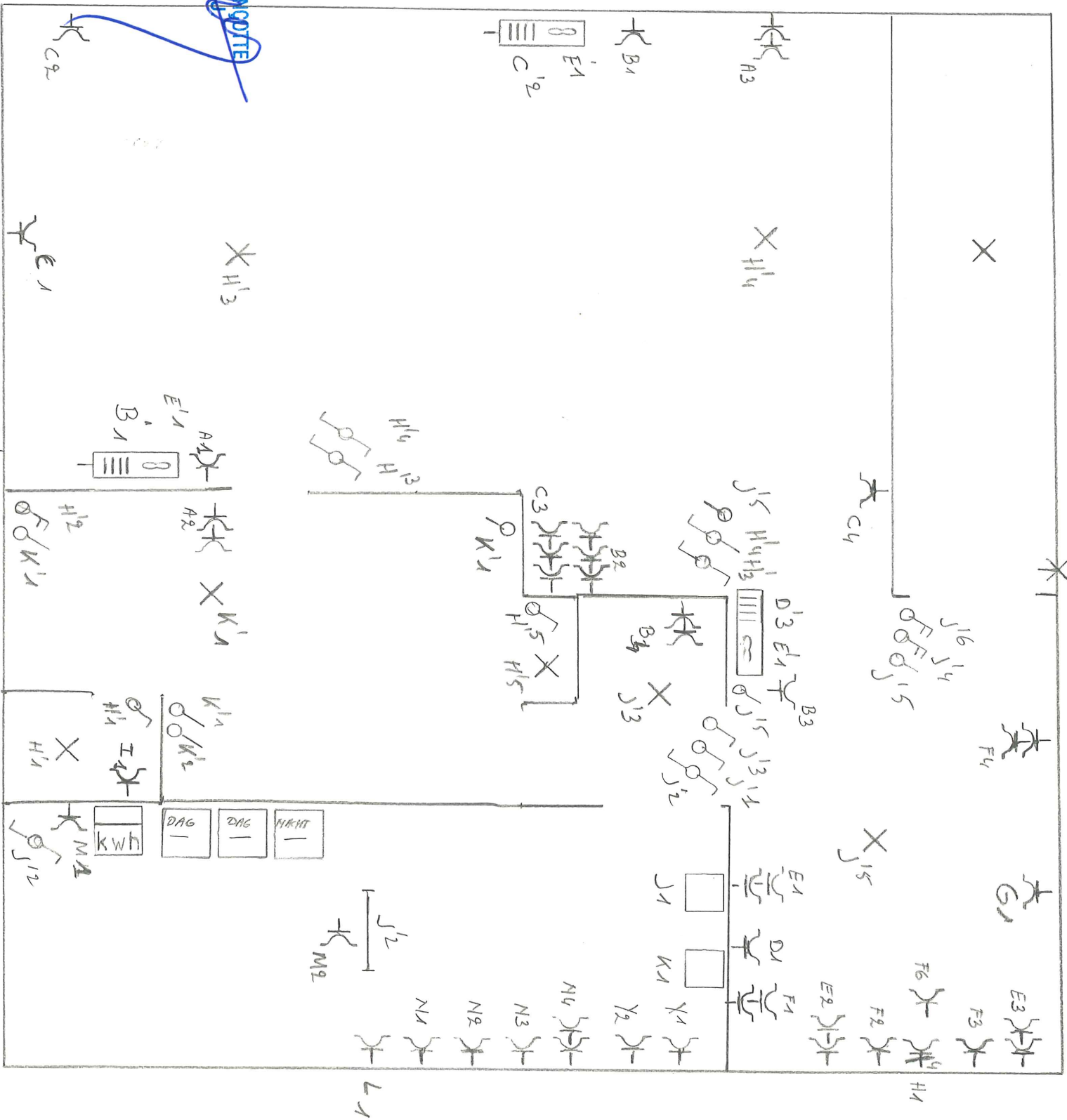

Gelykloos

Voor A.L.B. MINGOTTE
GERMIS
1874

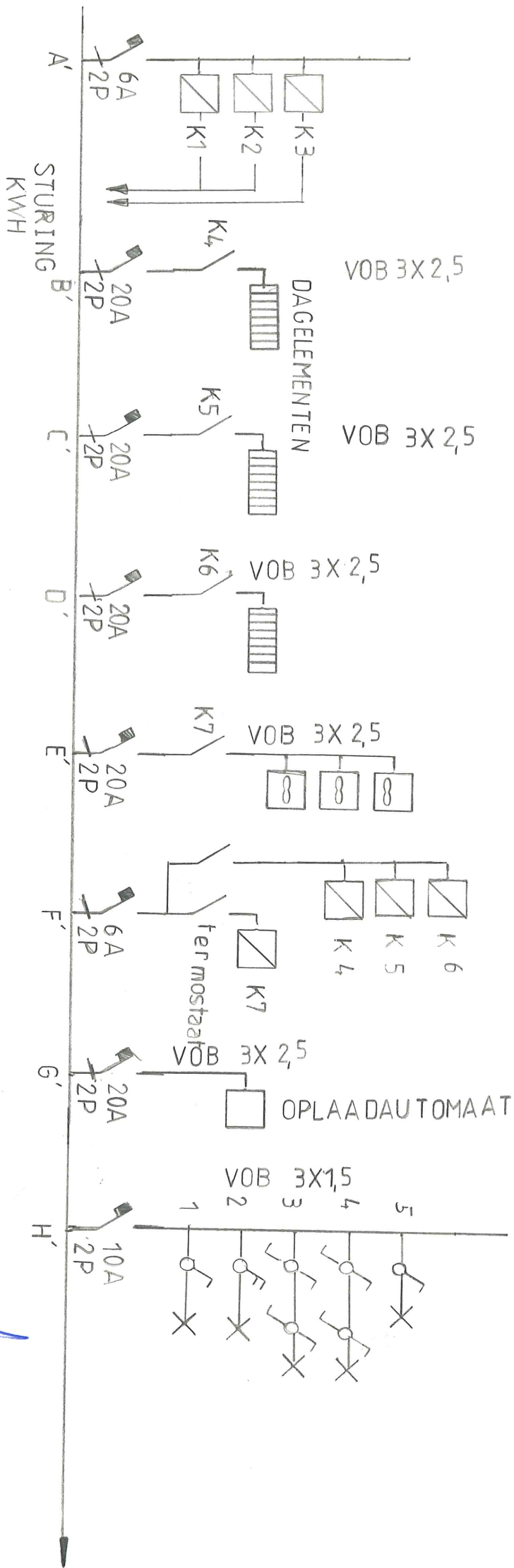

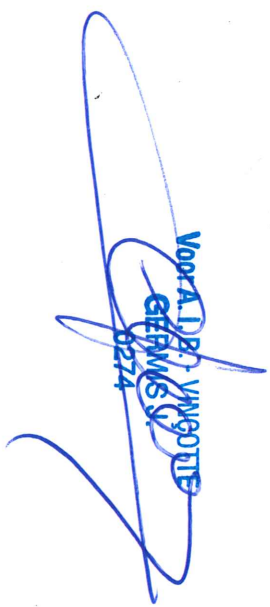

 VOORZIJDER WINGOITIE
 GEMINSKAP
 0274

NACHTBORD

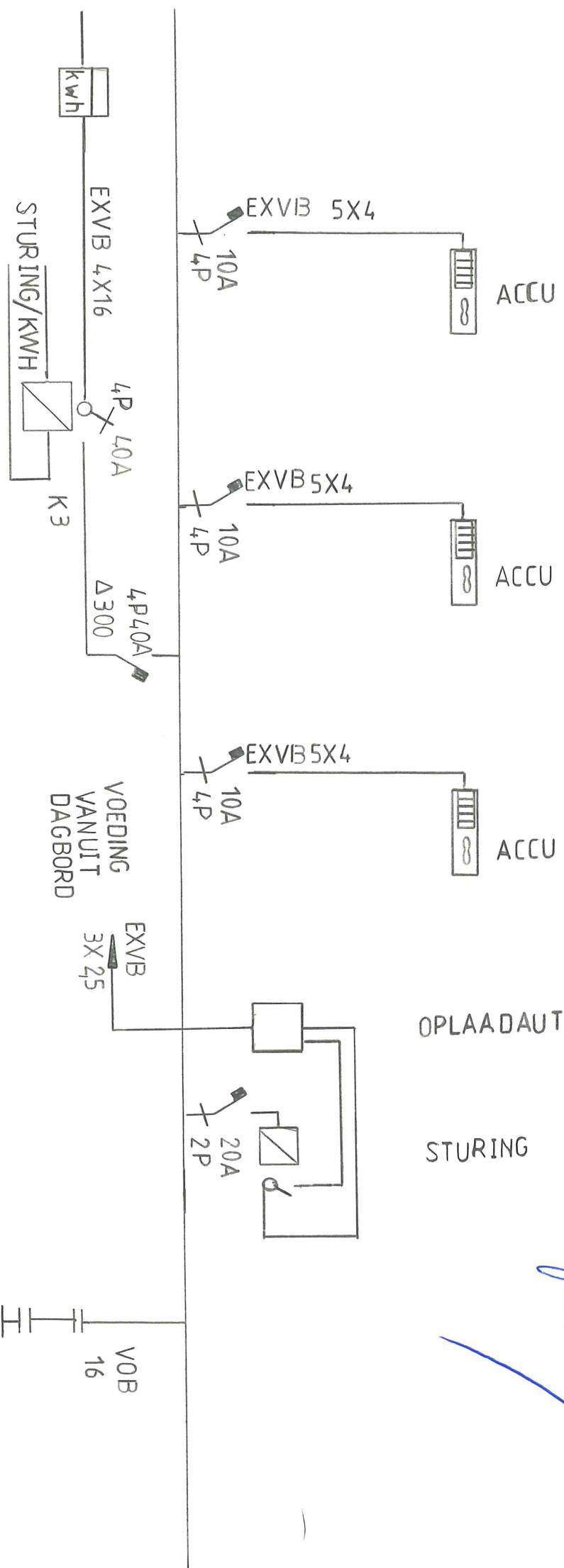

OPLAADAUTOMAAT

STURING

Voor A/B - YINGSTE
GEZINS
0274

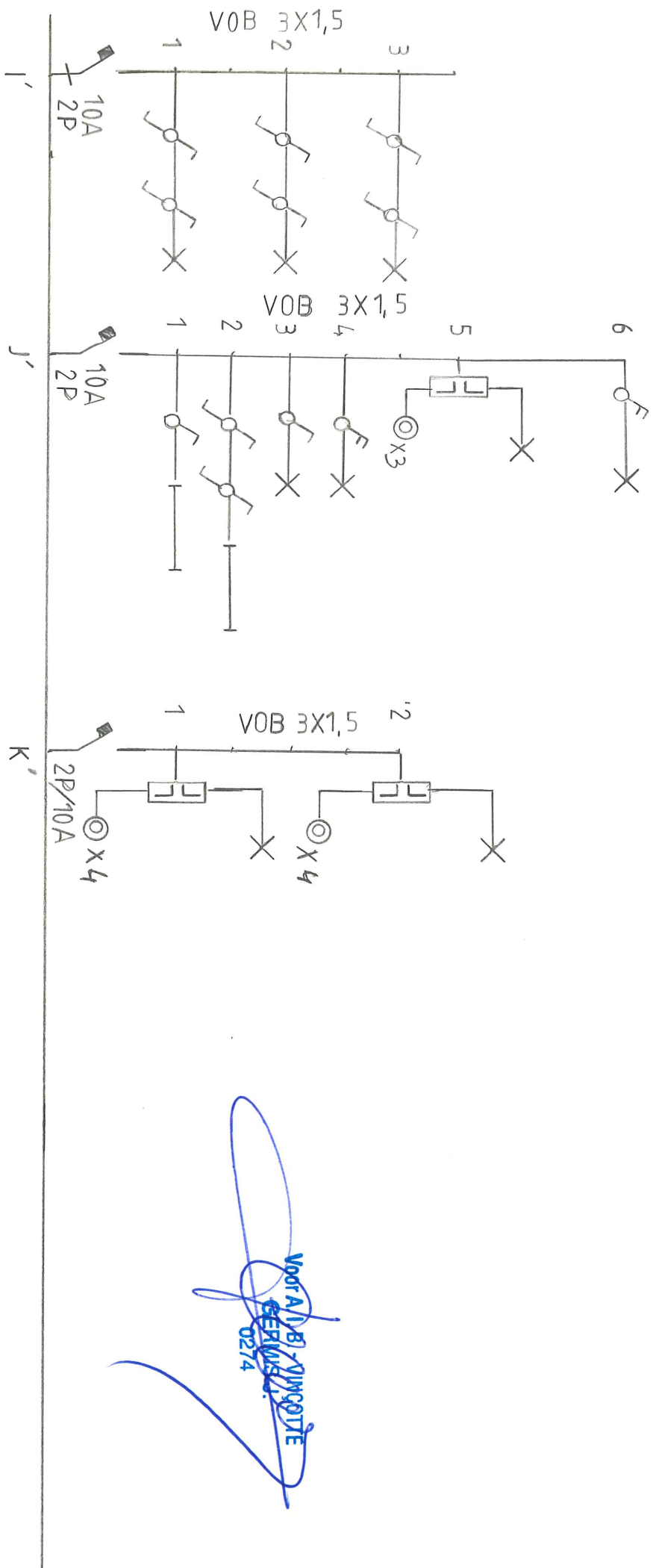

 VOOR A/B VINGOTTE
 GEMIS
 02/4

